

# Product data sheet

Specifications

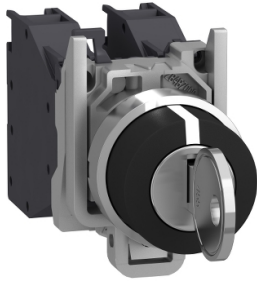

Key switch selector, Harmony XB4, metal, black, 22mm, key 455, 3 positions, stay put, 2 NO

XB4BG03

Product availability: Stock - Normally stocked in distribution facility

**Price\*: 141.00 USD**

## Main

Range of Product	Harmony XB4
Product or Component Type	Selector switch
Device short name	XB4
Bezel material	Chromium plated metal
Fixing collar material	Zamak
Mounting diameter	0.9 in (22.5 mm)
Sale per indivisible quantity	1
Head type	Standard
Shape of signaling unit head	Round
Type of operator	stay put
Operator profile	Black key switch
Operator position information	3 positions +/- 45°
Contacts type and composition	2 NO
Contact operation	Slow-break
Connections - terminals	Screw clamp terminals, <= 2 x 1.5 mm <sup>2</sup> with cable end IEC 60947-1 Screw clamp terminals, >= 1 x 0.22 mm <sup>2</sup> without cable end IEC 60947-1

## Complementary

Height	1.9 in (47 mm)
Width	1.2 in (30 mm)
Depth	3.4 in (86 mm)
Terminals description ISO n°1	(23-24)NO (13-14)NO
Net Weight	0.280 lb(US) (0.127 kg)
Resistance to high pressure washer	1015.3 psi (7000000 Pa) 131.0000000000 °F (55 °C) 0.1 m
type of keylock	Key 455
Key withdrawal position	In any position
Contacts usage	Standard contacts
Positive opening	Without
Torque value	1.24 lbf.in (0.14 N.m) NO changing electrical state
Mechanical durability	1000000 cycles

Price is "List Price" and may be subject to a trade discount – check with your local distributor or retailer for actual price.

<b>Tightening torque</b>	7.08...10.6 lbf.in (0.8...1.2 N.m) IEC 60947-1
<b>Shape of screw head</b>	Cross Philips no 1 Cross pozidriv No 1 Slotted flat Ø 4 mm Slotted flat Ø 5.5 mm
<b>Contacts material</b>	Silver alloy (Ag/Ni)
<b>Short-circuit protection</b>	10 A cartridge fuse gG IEC 60947-5-1
<b>[Ith] conventional free air thermal current</b>	10 A IEC 60947-5-1
<b>[Ui] rated insulation voltage</b>	600 V 3)IEC 60947-1
<b>[Uimp] rated impulse withstand voltage</b>	6 kV IEC 60947-1
<b>[Ie] rated operational current</b>	3 A 240 V, AC-15, A600 IEC 60947-5-1 6 A 120 V, AC-15, A600 IEC 60947-5-1 0.1 A 600 V, DC-13, Q600 IEC 60947-5-1 0.27 A 250 V, DC-13, Q600 IEC 60947-5-1 0.55 A 125 V, DC-13, Q600 IEC 60947-5-1 1.2 A 600 V, AC-15, A600 IEC 60947-5-1
<b>Electrical durability</b>	1000000 cycles, AC-15, 2 A 230 V 3600 cyc/h 0.5 EN 60947-5-1 appendix C 1000000 cycles, AC-15, 3 A 120 V 3600 cyc/h 0.5 EN 60947-5-1 appendix C 1000000 cycles, AC-15, 4 A 24 V 3600 cyc/h 0.5 EN 60947-5-1 appendix C 1000000 cycles, DC-13, 0.2 A 110 V 3600 cyc/h 0.5 EN 60947-5-1 appendix C 1000000 cycles, DC-13, 0.5 A 24 V 3600 cyc/h 0.5 EN 60947-5-1 appendix C
<b>Electrical reliability</b>	$\Lambda < 10\exp(-6)$ 5 V 1 mA in clean environment IEC 60947-5-4 $\Lambda < 10\exp(-8)$ 17 V 5 mA in clean environment IEC 60947-5-4
<b>Device presentation</b>	Complete product

## Environment

<b>protective treatment</b>	TH
<b>Ambient Air Temperature for Storage</b>	-40.0000000000...158.0000000000 °F (-40...70 °C)
<b>Ambient Air Temperature for Operation</b>	-40.0000000000...158.0000000000 °F (-40...70 °C)
<b>Overvoltage category</b>	Class I IEC 60536
<b>IP degree of protection</b>	IP66 IEC 60529 IP69 IP69K IP67
<b>NEMA degree of protection</b>	NEMA 13 NEMA 4X
<b>IK degree of protection</b>	IK06 with keyhole cover ZBGP conforming to IEC 50102
<b>Standards</b>	UL 508 IEC 60947-5-5 IEC 60947-5-1 IEC 60947-5-4 CSA C22.2 No 14 JIS C8201-5-1 IEC 60947-1 JIS C8201-1
<b>Product Certifications</b>	GL UL LROS (Lloyds register of shipping) DNV CSA BV
<b>Vibration resistance</b>	5 gn 2...500 Hz)IEC 60068-2-6
<b>Shock resistance</b>	30 gn 18 ms) half sine wave acceleration IEC 60068-2-27 50 gn 11 ms) half sine wave acceleration IEC 60068-2-27

## Ordering and shipping details

Category	US10CS222468
Discount Schedule	0CS2
GTIN	3389110887167
Returnability	Yes
Country of origin	US

## Packing Units

Unit Type of Package 1	PCE
Number of Units in Package 1	1
Package 1 Height	1.4 in (3.5 cm)
Package 1 Width	2.2 in (5.7 cm)
Package 1 Length	3.7 in (9.3 cm)
Package 1 Weight	5.6 oz (159 g)
Unit Type of Package 2	S02
Number of Units in Package 2	50
Package 2 Height	5.9 in (15 cm)
Package 2 Width	11.8 in (30 cm)
Package 2 Length	15.7 in (40 cm)
Package 2 Weight	18.179 lb(US) (8.246 kg)

## Contractual warranty

Warranty	18 months
----------	-----------

## Sustainability

**Green Premium™ label** is Schneider Electric's commitment to delivering products with best-in-class environmental performance. Green Premium promises compliance with the latest regulations, transparency on environmental impacts, as well as circular and low-CO<sub>2</sub> products.

**Guide to assessing product sustainability** is a white paper that clarifies global eco-label standards and how to interpret environmental declarations.

[Learn more about Green Premium >](#)

[Guide to assess a product's sustainability >](#)



Transparency RoHS/REACH

## Well-being performance

 Mercury Free

 RoHS Exemption Information Yes

## Certifications & Standards

Reach Regulation [REACH Declaration](#)

Eu RoHS Directive Pro-active compliance (Product out of EU RoHS legal scope)

China RoHS Regulation [China RoHS declaration](#)

Environmental Disclosure [Product Environmental Profile](#)

Weee The product must be disposed on European Union markets following specific waste collection and never end up in rubbish bins.

Circularity Profile [End of Life Information](#)

California Proposition 65 "WARNING: This product can expose you to chemicals including: Lead and lead compounds, which is known to the State of California to cause cancer and birth defects or other reproductive harm. For more information go to [www.P65Warnings.ca.gov](http://www.P65Warnings.ca.gov)"

Dimensions Drawings

Dimensions

---

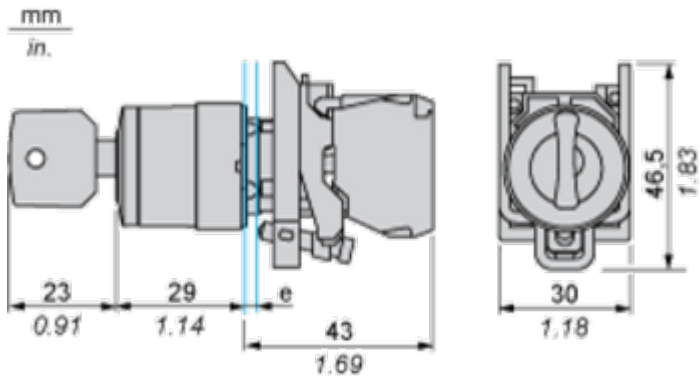

e : clamping thickness: 1 to 6 mm / 0.04 to 0.24 in.

Mounting and Clearance

Panel Cut-out for Pushbuttons, Switches and Pilot Lights (Finished Holes, Ready for Installation)

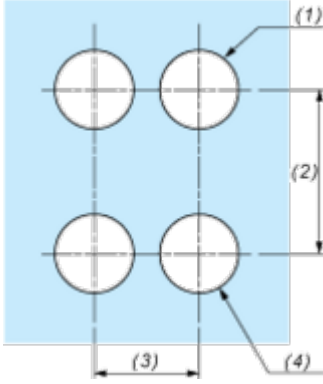
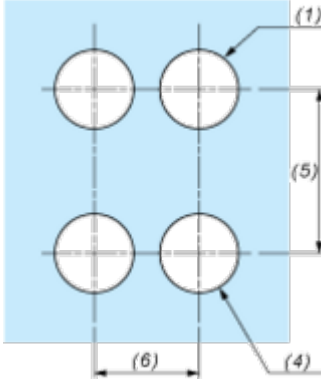
Connection by Screw Clamp Terminals or Plug-in Connectors or on Printed Circuit Board	Connection by Faston Connectors
	
<p>(1) Diameter on finished panel or support</p> <p>(2) 40 mm min. / 1.57 in. min.</p> <p>(3) 30 mm min. / 1.18 in. min.</p> <p>(4) <math>\varnothing 22.5 \text{ mm} / 0.89 \text{ in. recommended } (\varnothing 22.3 \text{ mm }_0^{+0.4} / 0.88 \text{ in. }_0^{+0.016})</math></p> <p>(5) 45 mm min. / 1.78 in. min.</p> <p>(6) 32 mm min. / 1.26 in. min.</p>	

Technical Illustration

Dimensions

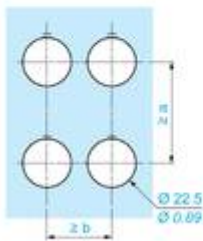
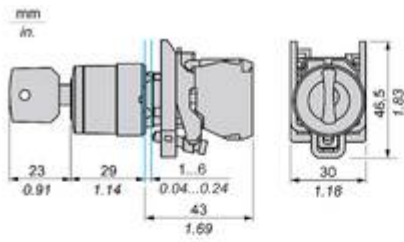

		a (mm)	a (in.)	b (mm)	b (in.)
		40	1.57	30	1.18
ZBE.....	ZBV.....				
		45	1.77	32	1.26
ZBE.....3	ZBV.....3				
		40	1.57	30	1.18
ZBE.....4	ZBV.....4				
		50	1.97	30	1.18
ZBE.....5	ZBV.....5				
		40	1.57	30	1.18
ZBE.....9	ZBV.....9				
		40	1.57	30	1.18
ZBRT..	ZBRV1				

Offer Marketing Illustration

Product benefits / Features

---

### Features Harmony XB4

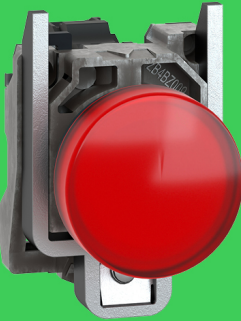

- 

Quick and easy assembly and disassembly
- 

Various types of connection: screw clamp, connector, Faston connector, spring terminal, or printed circuit board
- 

Excellent mechanical connection with operator head
- 

Large set of accessories to customize your panels
- 

Robustness to withstand harsh environments



Image of product / Alternate images

Alternative

---

