

# Product datasheet

Specifications



Push button, Harmony XB4, metal, flush, red, 22mm, spring return, unmarked, 1NC

XB4BA42

## Main

Range of product	Harmony XB4
Product or component type	Push-button
Device short name	XB4
Bezel material	Chromium plated metal
Fixing collar material	Zamak
Mounting diameter	22.5 mm
Sale per indivisible quantity	1
Shape of signaling unit head	Round
Type of operator	spring return
Operator profile	Red flush, unmarked
Head type	Standard
Contacts type and composition	1 NC
Contact operation	Slow-break
Connections - terminals	Screw clamp terminals, $\leq 2 \times 1.5 \text{ mm}^2$ with cable end conforming to IEC 60947-1 Screw clamp terminals, $1 \times 0.22 \dots 2 \times 2.5 \text{ mm}^2$ without cable end conforming to IEC 60947-1

## Complementary

Height	47 mm
Width	30 mm
Depth	52 mm
Terminals description ISO n°1	(21-22)NC
Net weight	0.08 kg
Resistance to high pressure washer	7000000 Pa at 55 °C, distance : 0.1 m
Contacts usage	Standard contacts
Positive opening	With conforming to IEC 60947-5-1 appendix K
Operating travel	1.5 mm (NC changing electrical state) 4.3 mm (total travel)
Operating force	3.5 N NC changing electrical state
Mechanical durability	10000000 cycles
Tightening torque	0.8...1.2 N.m conforming to IEC 60947-1

<b>Shape of screw head</b>	Cross compatible with Philips no 1 screwdriver Cross compatible with pozidriv No 1 screwdriver Slotted compatible with flat Ø 4 mm screwdriver Slotted compatible with flat Ø 5.5 mm screwdriver
<b>Contacts material</b>	Silver alloy (Ag/Ni)
<b>Short-circuit protection</b>	10 A cartridge fuse type gG conforming to IEC 60947-5-1
<b>[Ith] conventional free air thermal current</b>	10 A conforming to IEC 60947-5-1
<b>[Ui] rated insulation voltage</b>	600 V (pollution degree 3) conforming to IEC 60947-1
<b>[Uimp] rated impulse withstand voltage</b>	6 kV conforming to IEC 60947-1
<b>[Ie] rated operational current</b>	3 A at 240 V, AC-15, A600 conforming to IEC 60947-5-1 6 A at 120 V, AC-15, A600 conforming to IEC 60947-5-1 0.1 A at 600 V, DC-13, Q600 conforming to IEC 60947-5-1 0.27 A at 250 V, DC-13, Q600 conforming to IEC 60947-5-1 0.55 A at 125 V, DC-13, Q600 conforming to IEC 60947-5-1 1.2 A at 600 V, AC-15, A600 conforming to IEC 60947-5-1
<b>Electrical durability</b>	1000000 cycles, AC-15, 2 A at 230 V, operating rate <3600 cyc/h, load factor: 0.5 conforming to IEC 60947-5-1 appendix C 1000000 cycles, AC-15, 3 A at 120 V, operating rate <3600 cyc/h, load factor: 0.5 conforming to IEC 60947-5-1 appendix C 1000000 cycles, AC-15, 4 A at 24 V, operating rate <3600 cyc/h, load factor: 0.5 conforming to IEC 60947-5-1 appendix C 1000000 cycles, DC-13, 0.2 A at 110 V, operating rate <3600 cyc/h, load factor: 0.5 conforming to IEC 60947-5-1 appendix C 1000000 cycles, DC-13, 0.5 A at 24 V, operating rate <3600 cyc/h, load factor: 0.5 conforming to IEC 60947-5-1 appendix C
<b>Electrical reliability</b>	$\Lambda < 10\exp(-6)$ at 5 V and 1 mA in clean environment conforming to IEC 60947-5-4 $\Lambda < 10\exp(-8)$ at 17 V and 5 mA in clean environment conforming to IEC 60947-5-4
<b>Device presentation</b>	Complete product

## Environment

<b>protective treatment</b>	TH
<b>Ambient air temperature for storage</b>	-40...70 °C
<b>Ambient air temperature for operation</b>	-40...70 °C
<b>Overvoltage category</b>	Class I conforming to IEC 60536
<b>IP degree of protection</b>	IP66 conforming to IEC 60529 IP67 IP69 IP69K
<b>NEMA degree of protection</b>	NEMA 13 NEMA 4X
<b>IK degree of protection</b>	IK06 conforming to IEC 50102
<b>Standards</b>	IEC 60947-5-5 UL 508 CSA C22.2 No 14 IEC 60947-5-4 IEC 60947-1 JIS C8201-5-1 IEC 60947-5-1 JIS C8201-1
<b>product certifications</b>	LROS (Lloyds register of shipping) GL BV CSA DNV UL listed
<b>Vibration resistance</b>	5 gn ( $f= 2...500$ Hz) conforming to IEC 60068-2-6

<b>Shock resistance</b>	30 gn (duration = 18 ms) for half sine wave acceleration conforming to IEC 60068-2-27 50 gn (duration = 11 ms) for half sine wave acceleration conforming to IEC 60068-2-27
-------------------------	--

## Packing Units

<b>Unit Type of Package 1</b>	PCE
<b>Number of Units in Package 1</b>	1
<b>Package 1 Height</b>	3.500 cm
<b>Package 1 Width</b>	5.500 cm
<b>Package 1 Length</b>	8.500 cm
<b>Package 1 Weight</b>	78.900 g
<b>Unit Type of Package 2</b>	S03
<b>Number of Units in Package 2</b>	150
<b>Package 2 Height</b>	30.000 cm
<b>Package 2 Width</b>	30.000 cm
<b>Package 2 Length</b>	40.000 cm
<b>Package 2 Weight</b>	12.268 kg
<b>Unit Type of Package 3</b>	P06
<b>Number of Units in Package 3</b>	1200
<b>Package 3 Height</b>	75.000 cm
<b>Package 3 Width</b>	80.000 cm
<b>Package 3 Length</b>	60.000 cm
<b>Package 3 Weight</b>	106.144 kg

## Contractual warranty

<b>Warranty</b>	18 months
-----------------	-----------

## Sustainability

**Green Premium™ label** is Schneider Electric's commitment to delivering products with best-in-class environmental performance. Green Premium promises compliance with the latest regulations, transparency on environmental impacts, as well as circular and low-CO<sub>2</sub> products.

**Guide to assessing product sustainability** is a white paper that clarifies global eco-label standards and how to interpret environmental declarations.

[Learn more about Green Premium >](#)

[Guide to assess a product's sustainability >](#)



Transparency RoHS/REACH

## Well-being performance

Reach Free Of Svhc

Toxic Heavy Metal Free

Mercury Free

Rohs Exemption Information Yes

## Certifications & Standards

**Reach Regulation**

[REACH Declaration](#)

**Eu Rohs Directive**

Pro-active compliance (Product out of EU RoHS legal scope)

[EU RoHS Declaration](#)

**China Rohs Regulation**

[China RoHS declaration](#)

**Environmental Disclosure**

[Product Environmental Profile](#)

**Weee**

The product must be disposed on European Union markets following specific waste collection and never end up in rubbish bins

**Circularity Profile**

[End of Life Information](#)

Dimensions Drawings

Dimensions

---

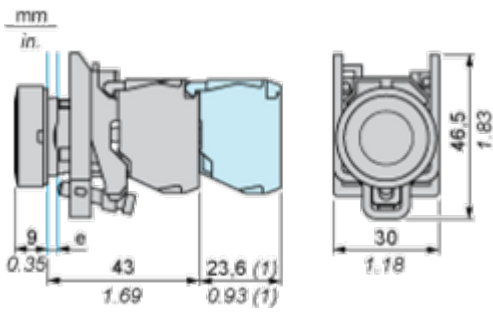

e : clamping thickness: 1 to 6 mm / 0.04 to 0.24 in.  
(1) Additional row of contacts or double contact.

Mounting and Clearance

Panel Cut-out for Pushbuttons, Switches and Pilot Lights (Finished Holes, Ready for Installation)

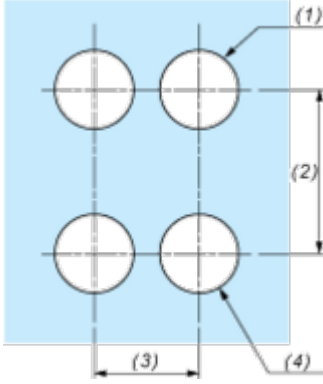
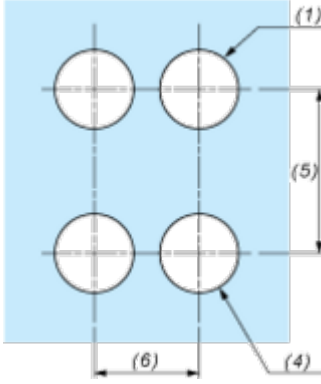
Connection by Screw Clamp Terminals or Plug-in Connectors or on Printed Circuit Board	Connection by Faston Connectors
	
<p>(1) Diameter on finished panel or support                  (2) 40 mm min. / 1.57 in. min.                  (3) 30 mm min. / 1.18 in. min.                  (4) <math>\varnothing 22.5 \text{ mm} / 0.89 \text{ in. recommended } (\varnothing 22.3 \text{ mm }_0^{+0.4} / 0.88 \text{ in. }_0^{+0.016})</math>                  (5) 45 mm min. / 1.78 in. min.                  (6) 32 mm min. / 1.26 in. min.</p>	

Technical Illustration

Dimensions

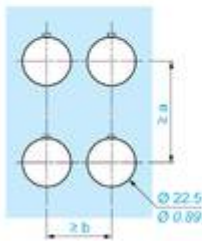
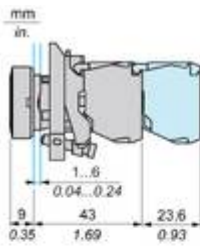

		a (mm)	a (in.)	b (mm)	b (in.)
		40	1.57	30	1.18
ZBE.....	ZBV.....				
		45	1.77	32	1.26
ZBE.....3	ZBV.....3				
		40	1.57	30	1.18
ZBE.....4	ZBV.....4				
		50	1.97	30	1.18
ZBE.....5	ZBV.....5				
		40	1.57	30	1.18
ZBE.....9	ZBV.....9				
		40	1.57	30	1.18
ZBR1	ZBRV1				

Offer Marketing Illustration

Product benefits / Features

---

### Features Harmony XB4

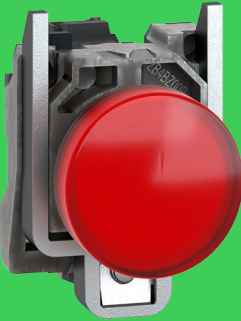

 Quick and easy assembly and disassembly

 Various types of connection: screw clamp, connector, Faston connector, spring terminal, or printed circuit board

 Excellent mechanical connection with operator head

 Large set of accessories to customize your panels

 Robustness to withstand harsh environments



Image of product / Alternate images

Alternative

---



